

AC/DC/IR Hipot Tester

MODEL 19070 SERIES 19050 SERIES

Key Features

- AC/DC/IR 3 in 1 hipot tester
- AC 5kV and DC 6kV output
- 1kV insulation resistance test
- Insulation resistance measurement from 1M Ω to 50G Ω
- Ground continuity check
- Standard RS-232 interface
- Open short check(OSC) function
- GFI shutdown the instrument when imbalance current > 0.5mA
- Flashover (ARC) detection
- Quick discharge of DUT in IR and DC test
- Pause mode
- UL and TUV approved (*see spec)
- CE mark
- Programmable ramp/fall and test time
- Programmable high/low limit
- Save/Recall program test function
- Remote control and interface support



AC/DC/IR HIPOT TESTER MODEL 19070 & 19050 SERIES

Complete Dielectric Testing Solution

The 19050 series electrical safety testers are advanced digital hipots with load and line regulation to ensure the measurement integrity. Multi-step capability allows users to perform multiple tests in a sequence such as AC hipot followed by IR.

The Chroma Hipot Tester 19050 series provides 3 models for choice. The 19052 is for AC/DC/IR Hipot testing and insulation resistance (IR) measurements. The 19053 IR measurement is with 8 scan channels, and the 19054 IR measurement is with 4 scan channels capability into a single compact unit.

The Chroma Hipot Tester 19070 series provides 2 models for choice. The 19071 is for AC Hipot testing. The 19073 combines both AC and DC Hipot with insulation resistance (IR) measurements into a single compact unit.

Open Short Check (OSC)

The OSC function is used to check whether the connection is open circuit between instrument and DUT or breakdown inside DUT before testing the electrical safety.

Flashover (ARC) Detection

The 19070 and 19050 series are sensitive enough to monitor current spikes even if they do not exceed the maximum trip current level.

Ground Continuity Check

All of the 19050 series testers have a ground continuity check feature to determine the resistance, that is between the ground blade of power cord and any exposed metal on the product, is less than 1 Ω .

Ground Fault Interrupt (GFI)

GFI is required by the National Electrical Code in wet locations. Such devices automatically interrupt power when a ground current > 0.5mA existed for more than a few milli-seconds to protect users.

Quick Discharge

In DC hipot and IR test the device under test is discharged back through the HV transformer. This technique results in a rapid and safe discharge.



Chroma



MAIN FUNCTIONS

FLASHOVER DETECTION

Fast transient in Voltage or Current occurred while Hi-Pot testing is called Electrical Flashover. Normally, in AC line frequency (50Hz/60Hz) or DC Hi-Pot testing, the leakage current is the same as 50Hz/60Hz or DC (charge current is excepted). As shown in Figure leakage current varies smoothly.

On the other hand, electrical discharge occurred because of poor insulation in material, electrode gap or surface clearance etc., fast transient in leakage current apparent as shown in figure. This is phenomenon of poor withstanding. Most of Electrical Safety regulations mention the necessity in Withstand Strength Test. Nevertheless, general Hi-Pot tester detects the RMS value of leakage current only without capability to detect Flashover. Therefore, FLASHOVER detection function equipped with Hi-Pot tester is necessary.

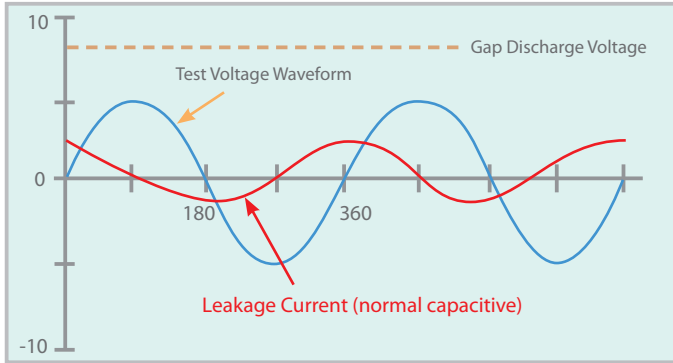

Figure 1 : Normal Leakage Current Waveform

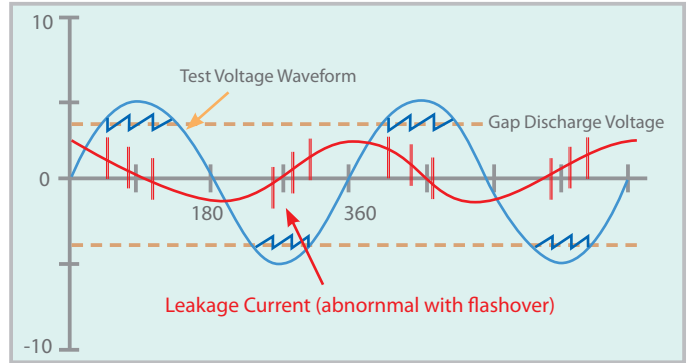
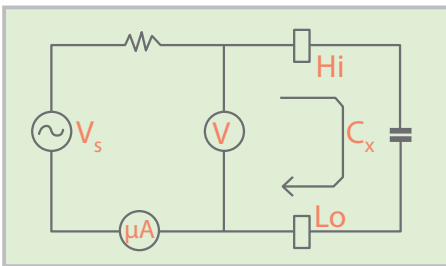

Figure 2 : Leakage Current Waveform when flashover occurred

OPEN/SHORT CHECK (OSC)

O.S.C function is used to check the connection is open or short circuit between instrument and DUT(equipment under test) before the Electrical Safety Test. If the connection is bad between the instrument and DUT, sometimes like leads or relay oxidation, the judgment is also PASS. In some cases, the DUT is short before testing. Testing continually leads to our instrument broken because suffered the high load current. Therefore, we have to check the open and short circuit to ensure the test effectively and protect instruments.

Generally, the DUT have capacitive load (C_x) from tens to thousands of pF. If the connection opening, a capacitance will appear and then total capacitive load is lower than that in normal condition. If the DUT shorting, total capacitive load is higher than that in normal condition. Therefore, we can measure the value of capacitive load to check the contact is good or not.



Normal Condition

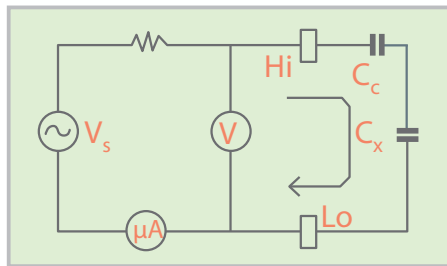

If Circuit Opened :
 $C = C_c * C_x / (C_c + C_x) \ll C_x$

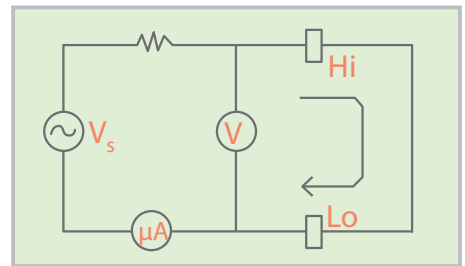

If Circuit Shorted :
 $C \gg C_x$

Ground Fault Interrupt (GFI)

The requirement of test environment indicates that test equipment is equipped with auto interrupt device so that Chroma develops into Ground Fault Interrupt (GFI) function. When the current meter A_1 and A_2 detect the difference ($i_2 - i_1 = i_H$) between the value i_1 and actual i_2 test current over high, this device can cut the power transiently for protecting human body safety. It is not only compliance with the safety standard but also more safeguards for test personnel.

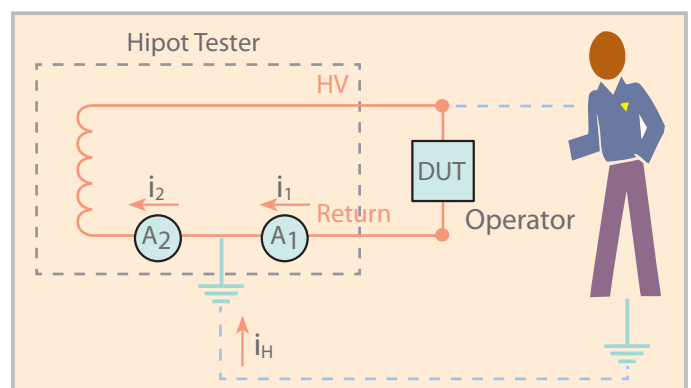

PANEL DESCRIPTION

19073

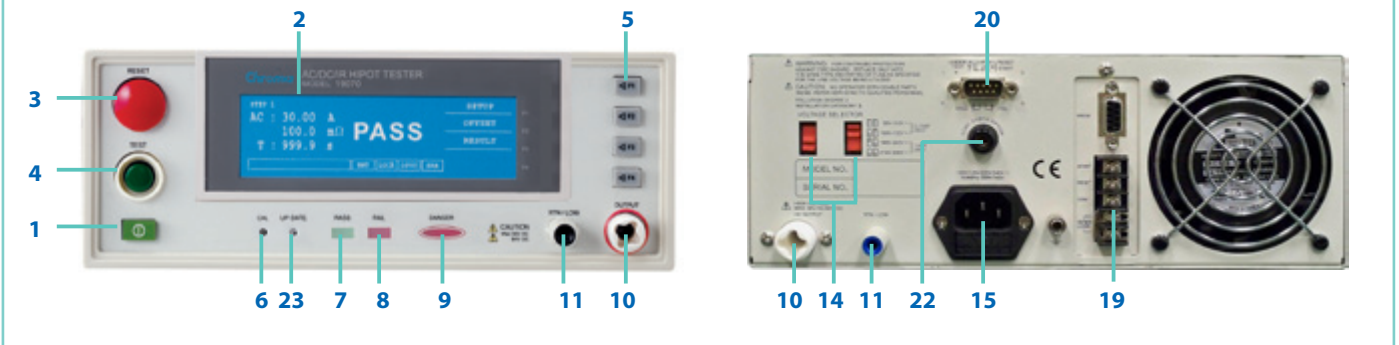

19053

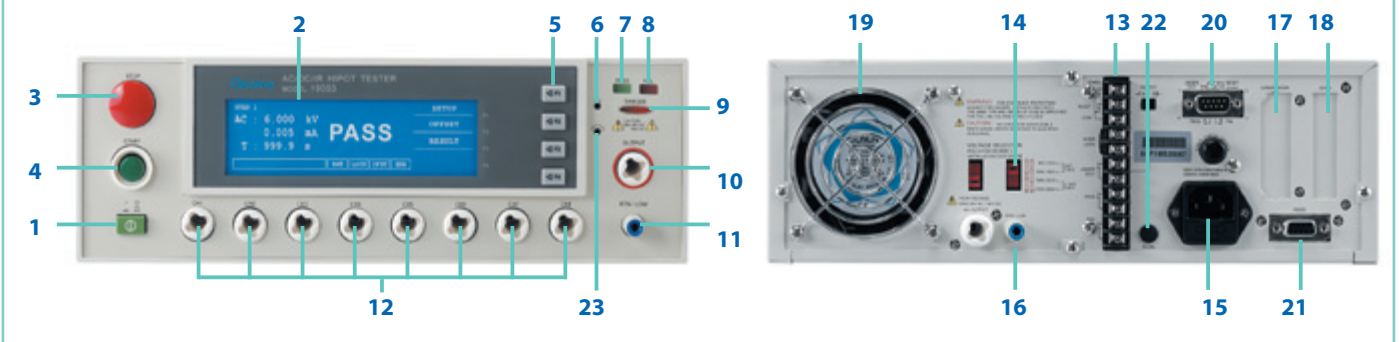

- | | | |
|--------------------------|---------------------------|-------------------------------------|
| 1. LINE Switch | 9. Test Indicator | 16. RTN/LOW |
| 2. Window Display | 10. HV Output | 17. GPIB/Printer Interface (Option) |
| 3. Stop Button | 11. RTN/LOW | 18. Scan Interface (Option) |
| 4. Start Button | 12. 8 channels HV Output | 19. Fan |
| 5. Function Keys (F1~F4) | (19053 only) | 20. Remote Interface |
| 6. Calibration Switch | 13. Remote I/O | 21. RS-232 Interface |
| 7. Pass Indicator | 14. LINE Voltage Selector | 22. Continuity Test O/P |
| 8. Fail Indicator | 15. Power Cord Receptacle | 23. Update Switch |

APPLICATION

- Production test of appliances, instruments and information technology equipment in accordance with UL, IEC, TUV and other standards such as EN 60335, EN 60950, EN 61010, CSA C22.2 No.1010.1, UL 3111 and UL 1950
- Transformer electrical safety test
- Electric motor safety test
- Various electronic components tests

ORDERING INFORMATION

- | | |
|---|--|
| 19071 : AC Hipot Tester | 19052 : Hipot Tester (AC/DC/IR) |
| 19073 : AC/DC/IR Hipot Tester | 19053 : Hipot Tester (AC/DC/IR/ 8CH SCAN) |
| A190701 : Remote Control Box | 19054 : Hipot Tester (AC/DC/IR/ 4CH SCAN) |
| A190702 : 40kV Test Probe | A190344 : HV Gun (SP02) |
| A190704 : Start Switch | A190508 : GPIB Interface |
| A190706 : 19" Rack Mount Kit | A190512 : Auto Control TR. Scan Box |
| A190708 : ARC Verification Fixture | A190517 : 19" Rack Mount Kit |

SPECIFICATIONS

Model	19071	19073	19052	19053	19054
Mode	AC	AC/DC/IR	AC/DC/IR	AC/DC/IR/SCAN	
Scanner Unit	-	-	-	8 ports,±phase	4 ports,±phase
Withstanding Voltage Test					
Output Voltage	AC : 0.05 ~ 5kV, DC : 0.05 ~ 6kV				
Load Regulation	1% of setting + 5V				
Voltage Resolution	2V				
Voltage Accuracy	1% of setting + 5 count				
Cutoff Current	AC : 0.1~20mA, DC : 0.01 ~ 5mA		AC : 0.1 ~ 30mA, DC : 0.01 ~ 10mA		
Current Resolution	AC : 1µA, DC : 0.1µA				
Current Accuracy	1% of setting + 5 count				
Output Frequency	50Hz / 60Hz				
Test Time	0.3 ~ 999 sec., continue				
Ramp Time	0.1 ~ 999 sec., off				
Fall Time	0.1 ~ 999 sec., off				
Dwell Time	0.1 ~ 999 sec., off				
Waveform	Sine wave				
Insulation Resistance					
Output Voltage	-	DC : 0.05 ~ 1kV			
Voltage Resolution	-	2V			
Voltage Accuracy	-	± (1.5% of reading + 5 counts)			
IR Range	-	1MΩ ~ 50GΩ		1MΩ ~ 10GΩ	
Resistance Accuracy	≥ 500V	1.00MΩ ~ 25.00MΩ	-	± (5% of reading + 2% of full scale)	
		22.0 MΩ ~ 250.0MΩ	-	± (5% of reading + 5% of full scale)	
		0.220GΩ ~ 1.000GΩ	-	± (10% of reading + 2% of full scale)	
	≤ 500V	1.000GΩ ~ 2.500 GΩ	-	± (15% of reading + 5% of full scale)	
		2.20GΩ ~ 10.00GΩ	-	± (15% of reading + 1% of scale)	
		10.00GΩ ~ 50.00GΩ	-	-	
Flashover (ARC) Detection					
Setting Mode	Programmable setting				
Detection Current	AC : 1mA ~ 15mA, DC : 1mA ~ 5mA		AC : 1mA ~ 15mA, DC : 1mA ~ 10mA		
Secure Protection Function					
Fast Output Cut-off	0.4ms after NG happen				
Ground Fault Interrupt	0.5mA ±0.25mA AC, ON/OFF				
Panel Operation Lock	Present password				
Continuity Check	1Ω ± 0.2Ω, ON/OFF				
GO/NG Judgment Window					
Indication, Alarm	GO : Short sound, Green LED ; NG : Long sound, Red LED				
Data Hold	Least tests data memories				
Memory Storage	60 steps in 60 groups		500 steps in 99 groups		
Remote & Interface					
Remote control	Input : Start, Stop, Interlock (at 11 pin terminal block only) ; Output : Under test, Pass, Fail				
Communication Interface	RS485 (Option)		RS232 (Standard), GPIB (Option).		
General					
Operation Environment	Temperature : 0°C~40°C, Humidity : 15% to 95% R.H@≤40°C				
Power Requirements	100V/120V/220V/240V (AC ±10%), 50/60Hz				
Power Consumption	300W		500W		
Dimension (W x H x D)	270 x 105 x 350 mm		320 x 105 x 400 mm		
Weight	Approx.12 KG		Approx.15 kg		
Certification	UL, TUV, CE		UL, TUV, CE	CE	UL, TUV, CE

*All specifications are subject to change without notice.

Developed and Manufactured by :

CHROMA ATE INC.

HEADQUARTERS
66 Hwaya 1st Rd., Kueishan
Hwaya Technology Park,
Taoyuan County 33383,
Taiwan
Tel: +886-3-327-9999
Fax: +886-3-327-8898
http://www.chromaate.com
E-mail: info@chromaate.com

CHINA
CHROMA ELECTRONICS
(SHENZHEN) CO., LTD.
8F, No.4, Nanyou Tian An
Industrial Estate, Shenzhen,
China PC: 518052
Tel: +86-755-2664-4598
Fax: +86-755-2641-9620

JAPAN
CHROMA JAPAN CORP.
472 Nippa-cho, Kouhoku-ku,
Yokohama-shi, Kanagawa,
223-0057 Japan
Tel: +81-45-542-1118
Fax: +81-45-542-1080
http://www.chroma.co.jp
E-mail: info@chromaate.com

U.S.A.
CHROMA SYSTEMS
SOLUTIONS, INC.
19772 Pauling,
Foothill Ranch, CA 92610
Tel: +1-949-600-6400
Fax: +1-949-600-6401
http://www.chromausa.com
E-mail: sales@chromausa.com

EUROPE
CHROMA ATE EUROPE B.V.
Morsestraat 32, 6716 AH Ede,
The Netherlands
Tel: +31-318-648282
Fax: +31-318-648288
http://www.chroma.eu.com
E-mail: sales@chromaeu.com

Worldwide Distribution and
Service Network

19070+19050-E-201407-PDF